

Advanced Multiprocessor Programming: Locks

Martin Wimmer, Jesper Larsson Träff

TU Wien

April 23th, 2018



FAKULTÄT
FÜR INFORMATIK

Faculty of Informatics



Locks we have seen so far

- Peterson Lock
- Filter Lock
- Bakery Lock

These locks ...

- ... use atomic registers
- ... have time and space complexity $O(n)$
- ... spin (busy waiting)

n : Number of threads

Problems with locks, recap

- Not compositional: Error prone, can lead to deadlocks if different locking conventions are used
- Priority inversion: In interaction with OS scheduler, a low priority thread holding a lock can block a high priority thread indefinitely by not being allowed to run because of a medium priority thread being scheduled
- Lock convoying: In interaction with OS scheduler, a descheduled thread holding a lock can cause other threads to queue up waiting for the lock; context switches between queued threads can be expensive

A typical lock interface

```
#include <pthread.h>

pthread_mutex_t mutex = PTHREAD_MUTEX_INITIALIZER;

int pthread_mutex_init(pthread_mutex_t *mutex,
                       const pthread_mutexattr_t *mutexattr);

int pthread_mutex_lock(pthread_mutex_t *mutex);
int pthread_mutex_trylock(pthread_mutex_t *mutex);
int pthread_mutex_timedlock(pthread_mutex_t *mutex,
                             const struct timespec *abs_timeout);

int pthread_mutex_unlock(pthread_mutex_t *mutex);

int pthread_mutex_destroy(pthread_mutex_t *mutex);
```

Two types of lock implementations:

- Spin lock: Thread actively keeps trying (test some condition) to acquire lock
- Blocking lock: Thread suspends, scheduler (OS) reawakens thread when lock becomes free

Performance considerations:

- Spin lock: Good if critical section short (fast), low overhead; but keeps processor busy (“burns cycles”)
- Blocking lock: Good for long critical sections, high (OS) overhead, processor/core can do something else

For coarse grained locking (pthreads), combinations often used:
Spin for some time, then block

Additional pthread locks

```
#include <pthread.h>

int pthread_spin_lock(pthread_spinlock_t *lock);
int pthread_spin_trylock(pthread_spinlock_t *lock);

int pthread_spin_unlock(pthread_spinlock_t *lock);
```

(Strange) Design decision: Programmer needs to rewrite code to use spin locks

Alternative (why not?): Use attribute at initialization to fix pragmatics

Higher consensus operations

- Consensus number 1
 - Atomic registers

- Consensus number 2
 - (flag) test-and-set
 - get-and-set (aka: exchange, swap)
 - fetch-and-add (also: fetch-and-inc, fetch-and-X)
 - wait-free FIFO queues (also: stack, list, ...)

- Consensus number n
 - swap (aka: exchange)

- Consensus number ∞
 - compare-and-swap (aka: compare-exchange)
 - load-linked - store-conditional

```
#include <stdatomic.h>

typedef /* unspecified */ atomic_flag;
_Bool atomic_flag_test_and_set( volatile atomic_flag* obj );
_Bool atomic_flag_test_and_set_explicit( volatile atomic_flag* obj, memory_order
    order );

C atomic_exchange( volatile A* obj, C desired );
C atomic_exchange_explicit( volatile A* obj, C desired, memory_order order );

_Bool atomic_compare_exchange_strong( volatile A* obj,
    C* expected, C desired );
_Bool atomic_compare_exchange_weak( volatile A *obj,
    C* expected, C desired );
_Bool atomic_compare_exchange_strong_explicit( volatile A* obj,
    C* expected, C desired,
    memory_order succ,
    memory_order fail );
_Bool atomic_compare_exchange_weak_explicit( volatile A *obj,
    C* expected, C desired,
    memory_order succ,
    memory_order fail );

C atomic_fetch_add( volatile A* obj, M arg );
C atomic_fetch_add_explicit( volatile A* obj, M arg, memory_order order );
C atomic_fetch_sub( volatile A* obj, M arg );
C atomic_fetch_sub_explicit( volatile A* obj, M arg, memory_order order );
// also: or, xor, and

void atomic_thread_fence( memory_order order );
```

Header <atomic>

```
template< class T > struct atomic;
template<> struct atomic<Integral>;
template< class T > struct atomic<T*>;

// Member functions
(constructor) // constructs an atomic object
operator= // stores a value into an atomic object
is_lock_free // checks if the atomic object is lock-free
store // atomically replaces the value of the atomic object with a non-atomic
        argument
load //atomically obtains the value of the atomic object
operator T // loads a value from an atomic object
exchange // atomically replaces the value of the atomic object and obtains the
        value held previously
compare_exchange_weak // atomically compares the value of the atomic object with
        non-atomic argument and performs atomic exchange if equal or atomic load if
        not
compare_exchange_strong
```

Header <atomic>

```
// Specialized member functions
fetch_add // atomically adds the argument to the value stored in the atomic object
           and obtains the value held previously
fetch_sub // atomically subtracts the argument from the value stored in the atomic
           object and obtains the value held previously
fetch_and // atomically performs bitwise AND between the argument and the value of
           the atomic object and obtains the value held previously
fetch_or  // atomically performs bitwise OR between the argument and the value of
           the atomic object and obtains the value held previously
fetch_xor // atomically performs bitwise XOR between the argument and the value of
           the atomic object and obtains the value held previously

operator++
operator-- // increments or decrements the atomic value by one
operator+=
operator-=
operator&=
operator|=
operator^= // adds, subtracts, or performs bitwise AND, OR, XOR with the atomic
           value
```

Native thread-model (somewhat like pthreads) with locks (mutexes) since C++11/C11. Use this (or pthreads)

```
#include <thread>

void myfunction()
{
    // make sure all threads start more or less at the same time
    // use mutex-condition variable, or (experimental) barrier construct
}

int main()
{
    // create and start threads (tree like, for larger number of threads
    std::thread t1(myfunction), t2(myfunction), t3(myfunction), t4(myfunction);

    // threads running, join back at end
    t1.join();
    t2.join();
    t3.join();
    t4.join();
}
```

OpenMP: Fork-join thread-model programming language extension. Can be used to easily start and synchronize threads.

```
#include <omp.h>

void benchmark() // called by master thread
{
    double threadtime[omp_get_max_threads()];

#pragma omp parallel // further clauses to control number of threads etc.
    {
        // threads active, per thread scope
        int p = omp_get_num_threads();
        int t = omp_get_thread_num();
        double start, stop;

#pragma omp barrier
        start = omp_get_wtime();

        // code to be benchmarked

        stop = omp_get_wtime();
        threadtime[t] = stop-start; // and other statistics
    }
    // only master thread active
}
```

Cost of atomic operations

- All $O(1)$, constant time, and wait-free instructions, implemented efficiently in hardware (CA: How?)
- Reasonable for `exchange` and `fetch_add`?
 - These must always succeed, high contention could cause delays

Higher consensus operations in action:

- Test-And-Set Lock
 - Single flag field per lock
 - Acquire lock by changing flag from false to true
→ locked on success
 - Reset flag to unlock

- Performance (surprisingly?) bad (why?)
 - Each test-and-set call invalidates cached copies for all threads
 - High contention on memory interconnect

```
bool locked = false; // atomic register

void lock() {
    while (test_and_set(&locked));
}

void unlock() {
    locked = false;
}
```

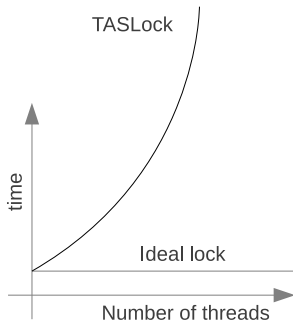

Test-And-Test-And-Set lock

- Test-and-set only if there is a chance of success
- Cache invalidated less often
- Still contention with more threads
- Relies on cache-coherence protocol implementation
- Beware of compiler optimizations (**volatile**)!

```
volatile bool locked = false;

void lock() {
    do {
        while (locked);
        if (!test_and_set(&locked)) return;
    } while (true);
}

void unlock() {
    locked = false;
}
```

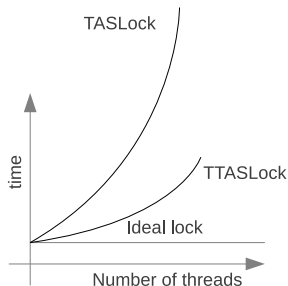

Exponential Backoff

- On failure to acquire lock:
 - Backoff with random duration
- Increase time to wait exponentially
 - Reduces contention
 - Try less often on high contention
 - Randomization ensures that threads wake up at different times
- Threads might wait longer than necessary!
- C++ note: Don't use rand()
 - Not thread-safe: Uses locks inside!
 - (Here: Thread-safe pseudo-function rnd())

```
class Backoff {
    int limit = MIN_DELAY;

    void backoff() {
        int delay = rnd() % limit;
        limit =
            min(MAX_DELAY, limit*2);
        sleep(delay); // suspend for
                       some time
    }
}
```

```
volatile bool locked = false;

void lock() {
    Backoff bo;
    do {
        while (locked);
        if (!test_and_set(&locked))
            return;
        bo.backoff();
    } while (true);
}

void unlock() {
    locked = false;
}
```

Test-And-Set-Locks: Summary

- Space complexity $O(1)$ for ∞ threads
 - Possible by test-and-set (consensus number 2)
- Unlock wait-free $O(1)$

- Problem with memory contention
 - All threads spin on a single memory location
(cache coherence traffic)
- Threads might wait longer than necessary due to backoff
- Unfair, and not starvation free
- “Fault-tolerant”: Stalled (crashed) thread not having lock will not prevent other threads from using lock

All functions called by a thread must be thread-safe: Can be called concurrently, outcomes depend only on thread-local state:

- Pure functions: No side-effects, no (global) state
- All functions called must likewise be thread-safe

Fair locks: Ticket Lock

- Atomic ticket counter
- Non-atomic served counter
- Lock: Take ticket and wait for served
- Unlock: Serve next

```
int ticket = 0; // atomic
volatile int served = 0;

void lock() {
    int next = fetch_add(&ticket)
    while (served < next) {}
}

void unlock() {
    served++;
}
```

Ticket Lock: Properties

- First-come, first-served, linearization by fetch-and-add
- Space efficient: $O(1)$ per lock!
- Unlock wait-free $O(1)$
- Ticket grows unboundedly
- Each thread spins on a local copy of a variable (in cache)
- **False sharing** might occur (if both served and ticket variables on same cache-line)

- **Slow (stalled, crashed) thread will stall later threads.** Not “fault-tolerant”

Too strong fairness; the following locks will have the same problem.
Problem: all threads before calling thread **must** be served.

Fair locks: Array Lock

- Circular array of atomic memory locations
- Lock: Spin on next free slot
- Unlock: Release slot

```
bool flags[n] =
    {true, false, false, false, ...}
int tail = 0; // atomic
thread_local int mySlot;

void lock() {
    mySlot = fetch_add(&tail,1) % n;
    while(!flags[mySlot]) {};
}

void unlock() {
    flags[mySlot] = false;
    flags[(mySlot + 1) % n] = true;
}
```

tail = 0

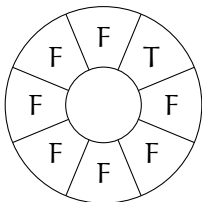

Fair locks: Array Lock

- Circular array of atomic memory locations
- Lock: Spin on next free slot
- Unlock: Release slot

```
bool flags[n] =
    {true, false, false, false, ...}
int tail = 0; // atomic
thread_local int mySlot;

void lock() {
    mySlot = fetch_add(&tail,1) % n;
    while(!flags[mySlot]) {};
}

void unlock() {
    flags[mySlot] = false;
    flags[(mySlot + 1) % n] = true;
}
```

tail = 1

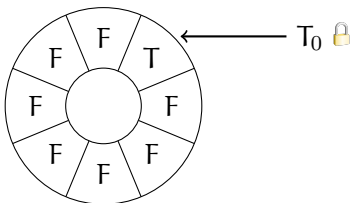

Fair locks: Array Lock

- Circular array of atomic memory locations
- Lock: Spin on next free slot
- Unlock: Release slot

```
bool flags[n] =
    {true, false, false, false, ...}
int tail = 0; // atomic
thread_local int mySlot;

void lock() {
    mySlot = fetch_add(&tail,1) % n;
    while(!flags[mySlot]) {};
}

void unlock() {
    flags[mySlot] = false;
    flags[(mySlot + 1) % n] = true;
}
```

tail = 2

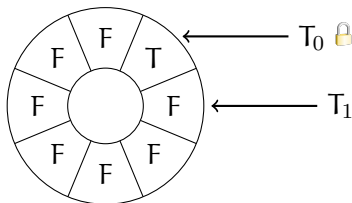

Fair locks: Array Lock

- Circular array of atomic memory locations
- Lock: Spin on next free slot
- Unlock: Release slot

```
bool flags[n] =
    {true, false, false, false, ...}
int tail = 0; // atomic
thread_local int mySlot;

void lock() {
    mySlot = fetch_add(&tail,1) % n;
    while(!flags[mySlot]) {};
}

void unlock() {
    flags[mySlot] = false;
    flags[(mySlot + 1) % n] = true;
}
```

tail = 3

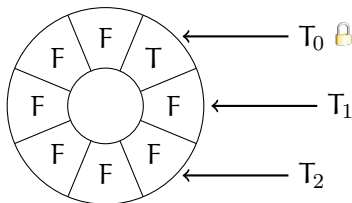

Fair locks: Array Lock

- Circular array of atomic memory locations
- Lock: Spin on next free slot
- Unlock: Release slot

```
bool flags[n] =
    {true, false, false, false, ...}
int tail = 0; // atomic
thread_local int mySlot;

void lock() {
    mySlot = fetch_add(&tail,1) % n;
    while(!flags[mySlot]) {};
}

void unlock() {
    flags[mySlot] = false;
    flags[(mySlot + 1) % n] = true;
}
```

tail = 3

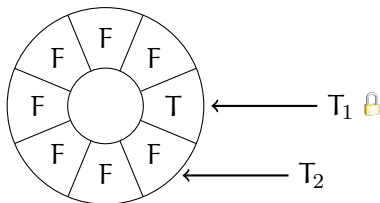

Fair locks: Array Lock

- Circular array of atomic memory locations
- Lock: Spin on next free slot
- Unlock: Release slot

```
bool flags[n] =
    {true, false, false, false, ...}
int tail = 0; // atomic
thread_local int mySlot;

void lock() {
    mySlot = fetch_add(&tail,1) % n;
    while(!flags[mySlot]) {};
}

void unlock() {
    flags[mySlot] = false;
    flags[(mySlot + 1) % n] = true;
}
```

tail = 3

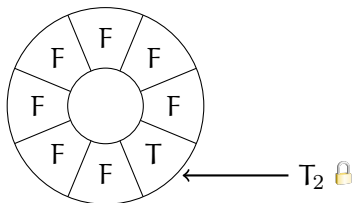

Fair locks: Array Lock

- Circular array of atomic memory locations
- Lock: Spin on next free slot
- Unlock: Release slot

```
bool flags[n] =
    {true, false, false, false, ...}
int tail = 0; // atomic
thread_local int mySlot;

void lock() {
    mySlot = fetch_add(&tail,1) % n;
    while(!flags[mySlot]) {};
}

void unlock() {
    flags[mySlot] = false;
    flags[(mySlot + 1) % n] = true;
}
```

tail = 3

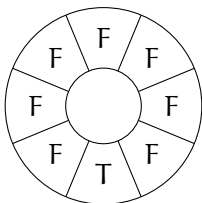

Array Lock: Properties

- First-come, first-served, linearization by fetch-and-add
- Unlock wait-free $O(1)$
- Less contention than simple test-and(-test-and)-set lock
 - Each thread spins on a local copy of a variable
 - **False sharing** might occur, resolvable by padding
- Not space efficient: $O(n)$ per lock!
- Not fault-tolerant

False sharing: Unrelated addresses on same cache-line still entail remote cache invalidation/updates.

CLH Queue Lock

- Independently by Craig & Landin and Hagersten
- Linked list
- Single Sentinel node
- Spin on locked flag of previous node

```
Node* tail = new Node();
tail->locked = false; // unlocked
thread_local Node* node;

void lock() {
    node = new Node();
    node->locked = true;
    node->pred = exchange(&tail, node);
    while (node->pred->locked) {}
}

void unlock() {
    delete node->pred;
    node->locked = false;
}
```

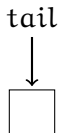

CLH Queue Lock

- Independently by Craig & Landin and Hagersten
- Linked list
- Single Sentinel node
- Spin on locked flag of previous node

```
Node* tail = new Node();
tail->locked = false; // unlocked
thread_local Node* node;

void lock() {
    node = new Node();
    node->locked = true;
    node->pred = exchange(&tail, node);
    while (node->pred->locked) {}
}

void unlock() {
    delete node->pred;
    node->locked = false;
}
```

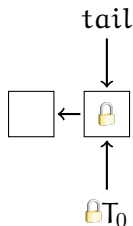

CLH Queue Lock

- Independently by Craig & Landin and Hagersten
- Linked list
- Single Sentinel node
- Spin on locked flag of previous node

```
Node* tail = new Node();
tail->locked = false; // unlocked
thread_local Node* node;

void lock() {
    node = new Node();
    node->locked = true;
    node->pred = exchange(&tail, node);
    while (node->pred->locked) {}
}

void unlock() {
    delete node->pred;
    node->locked = false;
}
```

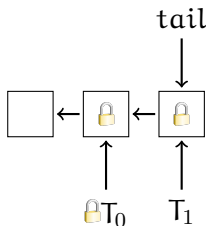

CLH Queue Lock

- Independently by Craig & Landin and Hagersten
- Linked list
- Single Sentinel node
- Spin on locked flag of previous node

```
Node* tail = new Node();  
tail->locked = false; // unlocked  
thread_local Node* node;  
  
void lock() {  
    node = new Node();  
    node->locked = true;  
    node->pred = exchange(&tail, node);  
    while (node->pred->locked) {}  
}  
  
void unlock() {  
    delete node->pred;  
    node->locked = false;  
}
```

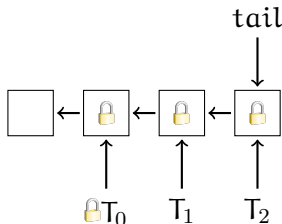

CLH Queue Lock

- Independently by Craig & Landin and Hagersten
- Linked list
- Single Sentinel node
- Spin on locked flag of previous node

```
Node* tail = new Node();
tail->locked = false; // unlocked
thread_local Node* node;

void lock() {
    node = new Node();
    node->locked = true;
    node->pred = exchange(&tail, node);
    while (node->pred->locked) {}
}

void unlock() {
    delete node->pred;
    node->locked = false;
}
```

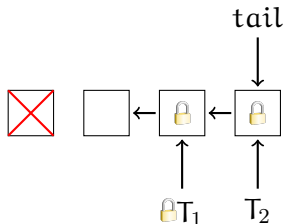

CLH Queue Lock

- Independently by Craig & Landin and Hagersten
- Linked list
- Single Sentinel node
- Spin on locked flag of previous node

```
Node* tail = new Node();
tail->locked = false; // unlocked
thread_local Node* node;

void lock() {
    node = new Node();
    node->locked = true;
    node->pred = exchange(&tail, node);
    while (node->pred->locked) {}
}

void unlock() {
    delete node->pred;
    node->locked = false;
}
```

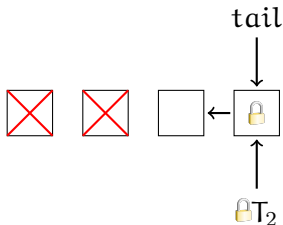

CLH Queue Lock

- Independently by Craig & Landin and Hagersten
- Linked list
- Single Sentinel node
- Spin on locked flag of previous node

```
Node* tail = new Node();
tail->locked = false; // unlocked
thread_local Node* node;

void lock() {
    node = new Node();
    node->locked = true;
    node->pred = exchange(&tail, node);
    while (node->pred->locked) {}
}

void unlock() {
    delete node->pred;
    node->locked = false;
}
```

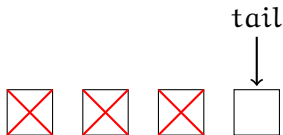

- C++ only supports static `thread_local` variables
 - Either pass on some data on lock and unlock
(if allowed by interface)
 - Or implement thread-local object storage yourself
(Or use `boost::thread_specific_ptr`)
- Differs slightly from Herlihy/Shavit
 - Predecessor stored in node
 - Manual memory management
 - Predecessor can safely be deleted at unlock
(no other thread accessing it)

CLH Queue Lock: Properties

- First-come, first-served, linearization by **exchange**
- Unlock wait-free $O(1)$
- $O(L)$ space, where L is the number of threads currently accessing the lock
 - More space depending on implementation of `thread_local` data
 - Herlihy/Shavit implementation requires $O(n)$
- Each thread spins on a separate location
 - Allocated locally by each thread, reduces false sharing
- Potential problem on NUMA architectures:
 - Locked field is in remote location
- Not fault-tolerant

MCS Queue Lock

- Reverse list
- Spin on field in own node
- To unlock, modify locked field of next node
- If no successor exists, reset tail



```
Node* tail = nullptr;
thread_local Node* node = new Node();

void lock() {
    Node* my = node;
    Node* pred = exchange(&tail, my);
    if (pred != nullptr) {
        my->locked = true;
        pred->next = my;
        while (my->locked);
    }
}

void unlock() {
    Node* my = node;
    if (my->next == nullptr) {
        if (compare_exchange(&tail, my,
                            nullptr))
            return;
        // Wait for next thread
        while (my->next == nullptr);
    }
    my->next->locked = false;
    my->next = nullptr;
}
```

MCS Queue Lock

- Reverse list
- Spin on field in own node
- To unlock, modify locked field of next node
- If no successor exists, reset tail

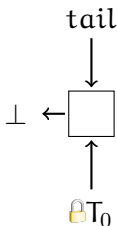

```
Node* tail = nullptr;
thread_local Node* node = new Node();

void lock() {
    Node* my = node;
    Node* pred = exchange(&tail, my);
    if (pred != nullptr) {
        my->locked = true;
        pred->next = my;
        while (my->locked);
    }
}

void unlock() {
    Node* my = node;
    if (my->next == nullptr) {
        if (compare_exchange(&tail, my,
                             nullptr))
            return;
        // Wait for next thread
        while (my->next == nullptr);
    }
    my->next->locked = false;
    my->next = nullptr;
}
```

MCS Queue Lock

- Reverse list
- Spin on field in own node
- To unlock, modify locked field of next node
- If no successor exists, reset tail

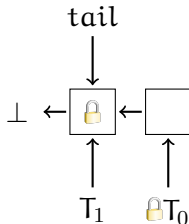

```
Node* tail = nullptr;
thread_local Node* node = new Node();

void lock() {
    Node* my = node;
    Node* pred = exchange(&tail, my);
    if (pred != nullptr) {
        my->locked = true;
        pred->next = my;
        while (my->locked);
    }
}

void unlock() {
    Node* my = node;
    if (my->next == nullptr) {
        if (compare_exchange(&tail, my,
                            nullptr))
            return;
        // Wait for next thread
        while (my->next == nullptr);
    }
    my->next->locked = false;
    my->next = nullptr;
}
```

MCS Queue Lock

- Reverse list
- Spin on field in own node
- To unlock, modify locked field of next node
- If no successor exists, reset tail

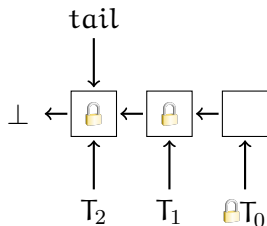

```
Node* tail = nullptr;
thread_local Node* node = new Node();

void lock() {
    Node* my = node;
    Node* pred = exchange(&tail, my);
    if (pred != nullptr) {
        my->locked = true;
        pred->next = my;
        while (my->locked);
    }
}

void unlock() {
    Node* my = node;
    if (my->next == nullptr) {
        if (compare_exchange(&tail, my,
                             nullptr))
            return;
        // Wait for next thread
        while (my->next == nullptr);
    }
    my->next->locked = false;
    my->next = nullptr;
}
```

MCS Queue Lock

- Reverse list
- Spin on field in own node
- To unlock, modify locked field of next node
- If no successor exists, reset tail

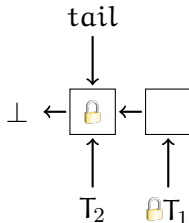

```
Node* tail = nullptr;
thread_local Node* node = new Node();

void lock() {
    Node* my = node;
    Node* pred = exchange(&tail, my);
    if (pred != nullptr) {
        my->locked = true;
        pred->next = my;
        while (my->locked);
    }
}

void unlock() {
    Node* my = node;
    if (my->next == nullptr) {
        if (compare_exchange(&tail, my,
                             nullptr))
            return;
        // Wait for next thread
        while (my->next == nullptr);
    }
    my->next->locked = false;
    my->next = nullptr;
}
```

MCS Queue Lock

- Reverse list
- Spin on field in own node
- To unlock, modify locked field of next node
- If no successor exists, reset tail

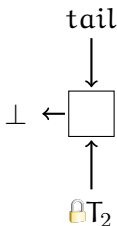

```
Node* tail = nullptr;
thread_local Node* node = new Node();

void lock() {
    Node* my = node;
    Node* pred = exchange(&tail, my);
    if (pred != nullptr) {
        my->locked = true;
        pred->next = my;
        while (my->locked);
    }
}

void unlock() {
    Node* my = node;
    if (my->next == nullptr) {
        if (compare_exchange(&tail, my,
                             nullptr))
            return;
        // Wait for next thread
        while (my->next == nullptr);
    }
    my->next->locked = false;
    my->next = nullptr;
}
```

MCS Queue Lock

- Reverse list
- Spin on field in own node
- To unlock, modify locked field of next node
- If no successor exists, reset tail



```
Node* tail = nullptr;
thread_local Node* node = new Node();

void lock() {
    Node* my = node;
    Node* pred = exchange(&tail, my);
    if (pred != nullptr) {
        my->locked = true;
        pred->next = my;
        while (my->locked);
    }
}

void unlock() {
    Node* my = node;
    if (my->next == nullptr) {
        if (compare_exchange(&tail, my,
                            nullptr))
            return;
        // Wait for next thread
        while (my->next == nullptr);
    }
    my->next->locked = false;
    my->next = nullptr;
}
```

MCS Queue Lock: Properties

- First-come, first-served
- $O(n)$ space total
 - More space depending on implementation of `thread_local` data
- Each thread spins on its own memory location
 - Updated by other thread
- No additional memory management

- Requires compare-and-swap
(consensus number ∞)
- Unlock not wait-free any more!
(Waiting for next lock owner to set `next` pointer)
- Not fault-tolerant

Space Requirements in Array and Queue Locks

- These locks are starvation free (first-come, first-served fair)
- Array and queue locks all need $\Omega(n)$ space (thread local nodes, slot in array); shown by Hendler/Fich/Shavit
- In this sense, higher consensus operations do not improve on the simple register locks

Queue Locks with timeouts (trylock)

- Abandoning is easy for Test-And-Set lock
 - Just stop trying to acquire lock
 - Timing out is wait-free
- More difficult for queue locks
 - If we just exit, the following thread will starve
 - Can't just unlink the node
(other thread might be accessing it)
- Lazy approach
 - Mark node as abandoned
 - Successor is responsible for cleanup

Queue Locks with timeouts (here: CLH Queue Lock)

- Add flag `abandoned` to nodes
- To abandon, set flag to `true`
- Next node is responsible for clean-up

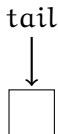

```
Node* tail = new Node();
thread_local Node* node;

bool try_lock(int timeout) {
    node = new Node();
    node->locked = true;
    node->abandoned = false;
    node->pred = exchange(&tail, node);
    int start = time();
    while (node->pred->locked) {
        if (node->pred->abandoned) {
            Node* pp = node->pred->pred;
            delete node->pred;
            node->pred = pp;
        }
        if (start + timeout <= time()) {
            node->abandoned = true;
            return false;
        }
    }
    return true;
}

void unlock() {
    delete node->pred;
    node->locked = false;
}
```

Queue Locks with timeouts (here: CLH Queue Lock)

- Add flag `abandoned` to nodes
- To abandon, set flag to `true`
- Next node is responsible for clean-up

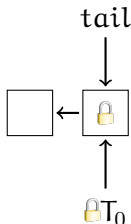

```
Node* tail = new Node();
thread_local Node* node;

bool try_lock(int timeout) {
    node = new Node();
    node->locked = true;
    node->abandoned = false;
    node->pred = exchange(&tail, node);
    int start = time();
    while (node->pred->locked) {
        if (node->pred->abandoned) {
            Node* pp = node->pred->pred;
            delete node->pred;
            node->pred = pp;
        }
        if (start + timeout <= time()) {
            node->abandoned = true;
            return false;
        }
    }
    return true;
}

void unlock() {
    delete node->pred;
    node->locked = false;
}
```

Queue Locks with timeouts (here: CLH Queue Lock)

- Add flag `abandoned` to nodes
- To abandon, set flag to `true`
- Next node is responsible for clean-up

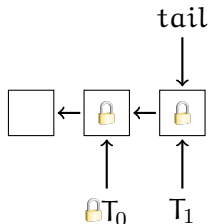

```
Node* tail = new Node();
thread_local Node* node;

bool try_lock(int timeout) {
    node = new Node();
    node->locked = true;
    node->abandoned = false;
    node->pred = exchange(&tail, node);
    int start = time();
    while (node->pred->locked) {
        if (node->pred->abandoned) {
            Node* pp = node->pred->pred;
            delete node->pred;
            node->pred = pp;
        }
        if (start + timeout <= time()) {
            node->abandoned = true;
            return false;
        }
    }
    return true;
}

void unlock() {
    delete node->pred;
    node->locked = false;
}
```

Queue Locks with timeouts (here: CLH Queue Lock)

- Add flag `abandoned` to nodes
- To abandon, set flag to `true`
- Next node is responsible for clean-up

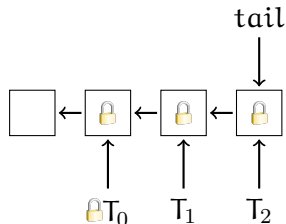

```
Node* tail = new Node();
thread_local Node* node;

bool try_lock(int timeout) {
    node = new Node();
    node->locked = true;
    node->abandoned = false;
    node->pred = exchange(&tail, node);
    int start = time();
    while (node->pred->locked) {
        if (node->pred->abandoned) {
            Node* pp = node->pred->pred;
            delete node->pred;
            node->pred = pp;
        }
        if (start + timeout <= time()) {
            node->abandoned = true;
            return false;
        }
    }
    return true;
}

void unlock() {
    delete node->pred;
    node->locked = false;
}
```

Queue Locks with timeouts (here: CLH Queue Lock)

- Add flag `abandoned` to nodes
- To abandon, set flag to `true`
- Next node is responsible for clean-up

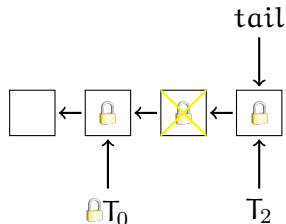

```
Node* tail = new Node();
thread_local Node* node;

bool try_lock(int timeout) {
    node = new Node();
    node->locked = true;
    node->abandoned = false;
    node->pred = exchange(&tail, node);
    int start = time();
    while (node->pred->locked) {
        if (node->pred->abandoned) {
            Node* pp = node->pred->pred;
            delete node->pred;
            node->pred = pp;
        }
        if (start + timeout <= time()) {
            node->abandoned = true;
            return false;
        }
    }
    return true;
}

void unlock() {
    delete node->pred;
    node->locked = false;
}
```

Queue Locks with timeouts (here: CLH Queue Lock)

- Add flag `abandoned` to nodes
- To abandon, set flag to `true`
- Next node is responsible for clean-up

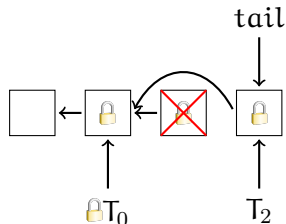

```
Node* tail = new Node();
thread_local Node* node;

bool try_lock(int timeout) {
    node = new Node();
    node->locked = true;
    node->abandoned = false;
    node->pred = exchange(&tail,node);
    int start = time();
    while (node->pred->locked) {
        if (node->pred->abandoned) {
            Node* pp = node->pred->pred;
            delete node->pred;
            node->pred = pp;
        }
        if (start + timeout <= time()) {
            node->abandoned = true;
            return false;
        }
    }
    return true;
}

void unlock() {
    delete node->pred;
    node->locked = false;
}
```

Queue Locks with timeouts (here: CLH Queue Lock)

- Add flag `abandoned` to nodes
- To abandon, set flag to `true`
- Next node is responsible for clean-up

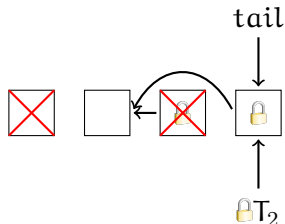

```
Node* tail = new Node();
thread_local Node* node;

bool try_lock(int timeout) {
    node = new Node();
    node->locked = true;
    node->abandoned = false;
    node->pred = exchange(&tail, node);
    int start = time();
    while (node->pred->locked) {
        if (node->pred->abandoned) {
            Node* pp = node->pred->pred;
            delete node->pred;
            node->pred = pp;
        }
        if (start + timeout <= time()) {
            node->abandoned = true;
            return false;
        }
    }
    return true;
}

void unlock() {
    delete node->pred;
    node->locked = false;
}
```

Queue Locks with timeouts (here: CLH Queue Lock)

- Add flag `abandoned` to nodes
- To abandon, set flag to `true`
- Next node is responsible for clean-up

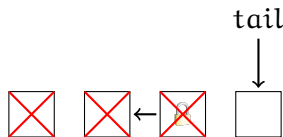

```
Node* tail = new Node();
thread_local Node* node;

bool try_lock(int timeout) {
    node = new Node();
    node->locked = true;
    node->abandoned = false;
    node->pred = exchange(&tail, node);
    int start = time();
    while (node->pred->locked) {
        if (node->pred->abandoned) {
            Node* pp = node->pred->pred;
            delete node->pred;
            node->pred = pp;
        }
        if (start + timeout <= time()) {
            node->abandoned = true;
            return false;
        }
    }
    return true;
}

void unlock() {
    delete node->pred;
    node->locked = false;
}
```

Composite Lock

- Combines Backoff lock and Queue lock
- Preallocate fixed number of nodes $< n$
- Acquire a random node
 - Only one thread may use a certain node
 - On failure back off
- As soon as a node is acquired, enqueue it
- Can be augmented with a fast path for low contention
 - If queue is empty, try fast path, on failure use normal path

```
Node nodes[k]; // preallocated

void lock() {
    Node* node;
    while(!(node =
        acquireNode(rnd() % k)))
        backoff();

    enqueueNode(node);
    waitForPredecessor(node);
}
```



Composite Lock

- Combines Backoff lock and Queue lock
- Preallocate fixed number of nodes $< n$
- Acquire a random node
 - Only one thread may use a certain node
 - On failure back off
- As soon as a node is acquired, enqueue it
- Can be augmented with a fast path for low contention
 - If queue is empty, try fast path, on failure use normal path

```
Node nodes[k]; // preallocated

void lock() {
    Node* node;
    while(!(node =
        acquireNode(rnd() % k)))
        backoff();

    enqueueNode(node);
    waitForPredecessor(node);
}
```

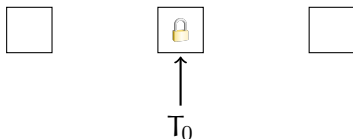

Composite Lock

- Combines Backoff lock and Queue lock
- Preallocate fixed number of nodes $< n$
- Acquire a random node
 - Only one thread may use a certain node
 - On failure back off
- As soon as a node is acquired, enqueue it
- Can be augmented with a fast path for low contention
 - If queue is empty, try fast path, on failure use normal path

```
Node nodes[k]; // preallocated

void lock() {
    Node* node;
    while(!(node =
        acquireNode(rnd() % k)))
        backoff();

    enqueueNode(node);
    waitForPredecessor(node);
}
```

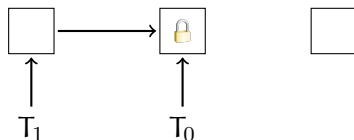

Composite Lock

- Combines Backoff lock and Queue lock
- Preallocate fixed number of nodes $< n$
- Acquire a random node
 - Only one thread may use a certain node
 - On failure back off
- As soon as a node is acquired, enqueue it
- Can be augmented with a fast path for low contention
 - If queue is empty, try fast path, on failure use normal path

```
Node nodes[k]; // preallocated

void lock() {
    Node* node;
    while(!(node =
        acquireNode(rnd() % k)))
        backoff();

    enqueueNode(node);
    waitForPredecessor(node);
}
```

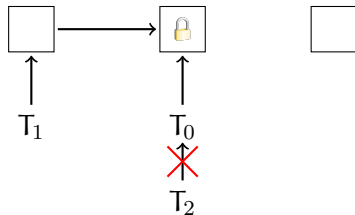

Composite Lock

- Combines Backoff lock and Queue lock
- Preallocate fixed number of nodes $n < k$
- Acquire a random node
 - Only one thread may use a certain node
 - On failure back off
- As soon as a node is acquired, enqueue it
- Can be augmented with a fast path for low contention
 - If queue is empty, try fast path, on failure use normal path

```
Node nodes[k]; // preallocated

void lock() {
    Node* node;
    while(!(node =
        acquireNode(rnd() % k)))
        backoff();

    enqueueNode(node);
    waitForPredecessor(node);
}
```

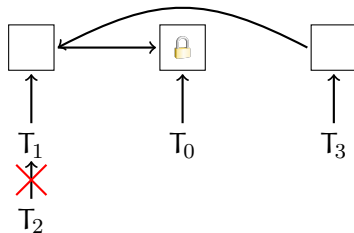

Composite Lock

- Combines Backoff lock and Queue lock
- Preallocate fixed number of nodes $n < k$
- Acquire a random node
 - Only one thread may use a certain node
 - On failure back off
- As soon as a node is acquired, enqueue it
- Can be augmented with a fast path for low contention
 - If queue is empty, try fast path, on failure use normal path

```
Node nodes[k]; // preallocated

void lock() {
    Node* node;
    while(!(node =
        acquireNode(rnd() % k)))
        backoff();

    enqueueNode(node);
    waitForPredecessor(node);
}
```

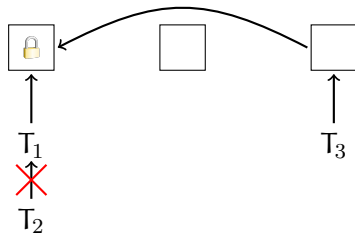

Composite Lock

- Combines Backoff lock and Queue lock
- Preallocate fixed number of nodes $< n$
- Acquire a random node
 - Only one thread may use a certain node
 - On failure back off
- As soon as a node is acquired, enqueue it
- Can be augmented with a fast path for low contention
 - If queue is empty, try fast path, on failure use normal path

```
Node nodes[k]; // preallocated

void lock() {
    Node* node;
    while(!(node =
        acquireNode(rnd() % k)))
        backoff();

    enqueueNode(node);
    waitForPredecessor(node);
}
```

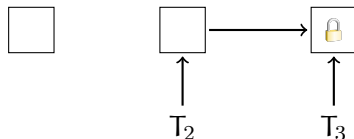

Composite Lock

- Combines Backoff lock and Queue lock
- Preallocate fixed number of nodes $< n$
- Acquire a random node
 - Only one thread may use a certain node
 - On failure back off
- As soon as a node is acquired, enqueue it
- Can be augmented with a fast path for low contention
 - If queue is empty, try fast path, on failure use normal path

```
Node nodes[k]; // preallocated

void lock() {
    Node* node;
    while(!(node =
        acquireNode(rnd() % k)))
        backoff();

    enqueueNode(node);
    waitForPredecessor(node);
}
```

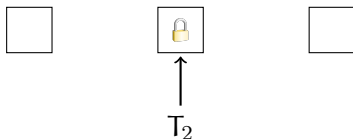

Composite Lock

- Combines Backoff lock and Queue lock
- Preallocate fixed number of nodes $< n$
- Acquire a random node
 - Only one thread may use a certain node
 - On failure back off
- As soon as a node is acquired, enqueue it
- Can be augmented with a fast path for low contention
 - If queue is empty, try fast path, on failure use normal path

```
Node nodes[k]; // preallocated

void lock() {
    Node* node;
    while(!(node =
        acquireNode(rnd() % k)))
        backoff();

    enqueueNode(node);
    waitForPredecessor(node);
}
```



Hierarchical Backoff Lock

- Original idea by Zoran Radovic and Erik Hagersten
- Based on Backoff Lock
- Length of backoff dependent on distance to lock owner
(2-level hierarchy common)
- Local threads are more likely to acquire lock
- May starve remote threads!

```
int noowner = 1;
int owner = noowner;

void lock() {
    int current_owner;
    while ((current_owner =
           compare_exchange(&owner,
                           &noowner,
                           thread_id()))
           != thread_id()) {
        int distance =
            memory_distance(current_owner,
                            thread_id());
        backoff(distance);
    }
}
```

Hierarchical CLH Lock

- By Victor Luchangco, Dan Nussbaum and Nir Shavit
- Multiple clusters of processors
- 1 global queue
- 1 local queue per cluster
- Add node to local queue
- First node in local queue is the cluster master and splices local queue into global queue
- Others wait until they have the lock or become cluster master

```
thread_local Node* pred, node;
// cluster local queues
cluster_local Node* lq;
Node* gq; // global queue

void lock()
{
    // Splice into local queue
    pred = exchange(&lq,node);

    if (pred != nullptr) {
        bool lock =
            wait_lock_or_master(pred);
        if (lock) // Lock acquired
            return;
    }

    // Thread is now cluster master

    // Splice local into global queue
    tail = *lq;
    pred = exchange(&gq,tail);
    node->pred = pred;

    // Successor is new cluster master
    tail->newmaster = true;

    // Wait for lock
    while (pred->locked);
}
```

Hierarchical CLH Lock

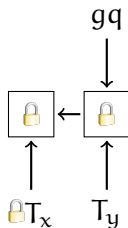

lq_1
↓
⊥

lq_2
↓
⊥

Hierarchical CLH Lock

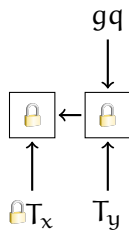

Hierarchical CLH Lock

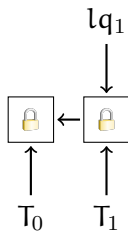
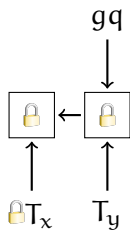

Hierarchical CLH Lock

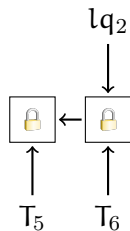
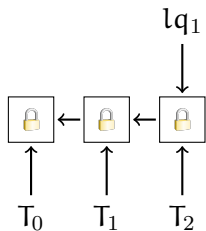
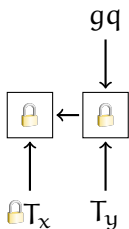

Hierarchical CLH Lock

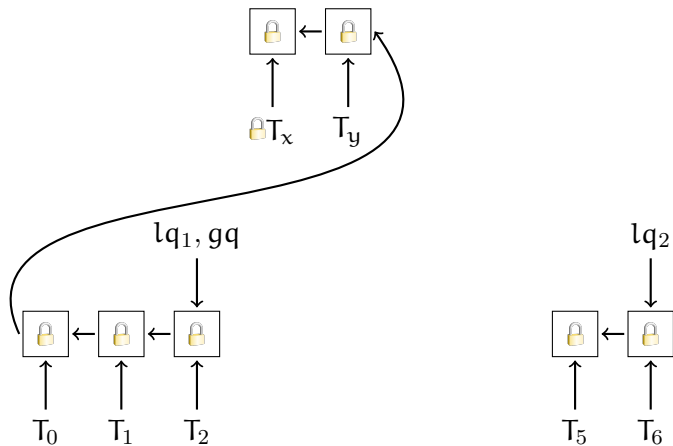

Hierarchical CLH Lock

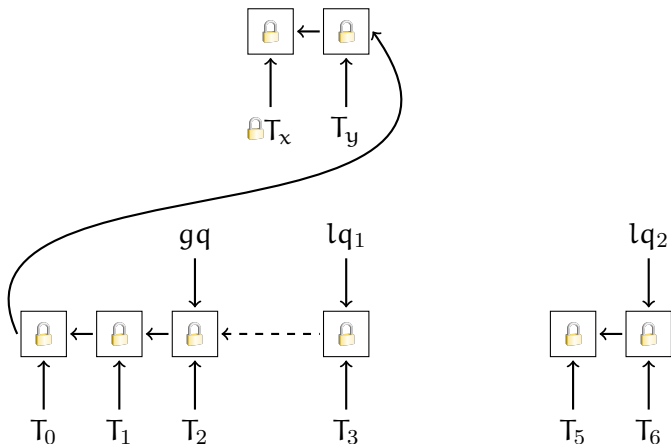

Hierarchical CLH Lock

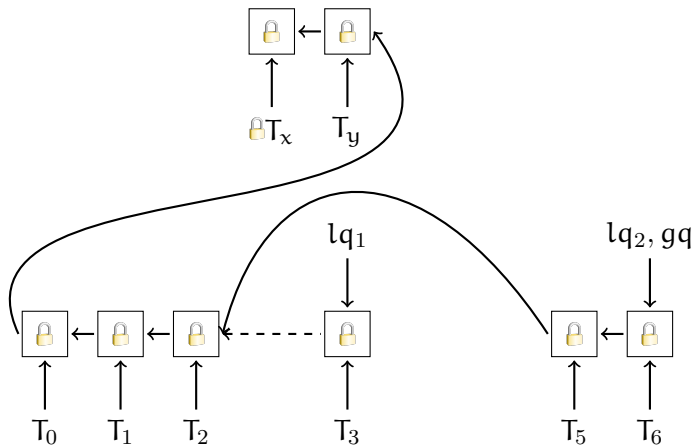

Hierarchical CLH Lock

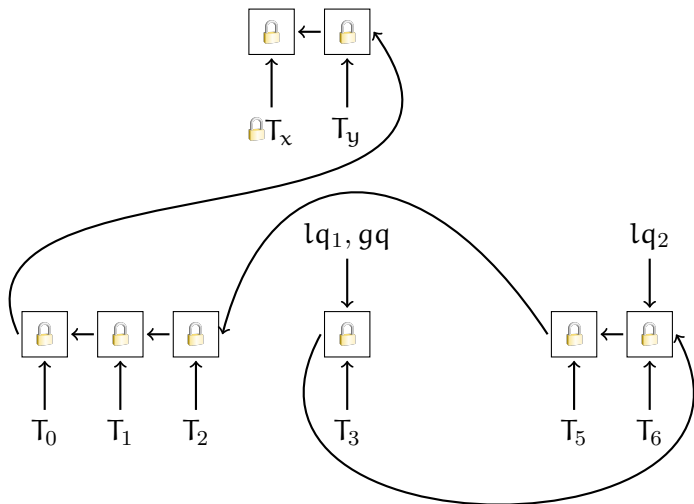

- Introduced in 2012 by David Dice, Virendra J. Marathe and Nir Shavit
- General technique to construct NUMA-aware locks from normal locks
- 1 global lock (not NUMA aware)
- 1 local lock per cluster
 - Requires cohort detection ability
(Other threads from same cluster wait for global lock)
- Threads must acquire both locks
 - Global lock can be passed around inside NUMA cluster
 - Release global lock at some point for fairness
- Supports abortable locks

- There is no one lock for every application
- Choice depends on congestion in application
- NUMA-awareness improves performance on modern systems
- Reader-Writer Locks not discussed in this lecture
 - See Herlihy-Shavit book
 - A recent result: NUMA-aware reader-writer locks by Calciu et al., PPOPP 2013

Many readers, at most one writer in critical section.

```
#include <pthread.h>

int pthread_rwlock_init(pthread_rwlock_t *restrict rwlock,
                        const pthread_rwlockattr_t *restrict attr);

int pthread_rwlock_rdlock(pthread_rwlock_t *rwlock);
int pthread_rwlock_tryrdlock(pthread_rwlock_t *rwlock);
int pthread_rwlock_trywrlock(pthread_rwlock_t *rwlock);
int pthread_rwlock_wrlock(pthread_rwlock_t *rwlock);

int pthread_rwlock_unlock(pthread_rwlock_t *rwlock);

int pthread_rwlock_destroy(pthread_rwlock_t *rwlock);
```

- Test-And-Set Locks
 - + Low overhead
 - + Abortable by design
 - Unfair
 - All threads spin on same memory location
 - Threads may wait longer than necessary with backoff
- Queue Locks
 - + Fair
 - + Threads spin on different locations
 - Hard to abort
 - Cleanup often difficult without garbage collection
 - Need $\Omega(n)$ space
- Composite Lock
 - + Tries to take advantages of both TAS locks and Queue locks
 - + Good at high congestion
 - High overhead on low congestion
 - Quite complex
- Hierarchical Locks
 - + Higher performance on NUMA systems due to less lock migrations
 - + Cohorting allows to use all lock types for NUMA-aware locks
 - Added complexity

- John M. Mellor-Crummey and Michael L. Scott. Algorithms for scalable synchronization on shared-memory multiprocessors. *ACM Trans. Comput. Syst.*, 9(1): 21–65, 1991.
- Travis S. Craig. Queuing spin lock algorithms to support timing predictability. In *Proceedings of the Real-Time Systems Symposium*, pages 148–157, 1993.
- Peter S. Magnusson, Anders Landin, and Erik Hagersten. Queue locks on cache coherent multiprocessors. In *Proceedings of the 8th International Symposium on Parallel Processing*, pages 165–171, 1994.
- David Dice, Virendra J. Marathe, and Nir Shavit. Lock cohorting: a general technique for designing NUMA locks. In *Proceedings of the 17th ACM SIGPLAN Symposium on Principles and Practice of Parallel Programming (PPOPP)*, pages 247–256, 2012.
- Faith Ellen, Danny Hendler, Nir Shavit. On the Inherent Sequentiality of Concurrent Objects. *SIAM J. Comput.*, 41(3): 519–536, 2012.